

European Technical Assessment

ETA-20/1177
 of 15/12/2020

General Part

Technical Assessment Body Issuing the European Technical Assessment:	Element Materials Technology Rotterdam B.V.
Trade Name of the Construction Product:	DrillFast® HT Fasteners MatchFast® HT Fasteners
Product Family to Which the Construction Product Belongs:	EC PAC 33
Manufacturer:	FixFast Ltd Merlin House Seven Mile Lane Borough Green Sevenoaks Kent TN15 8QY UK
Manufacturing Plant(s):	Details Held on File by Element
This European Technical Assessment Contains:	21 Pages including 1 Annex which forms an integral part of this assessment.
This European Technical Assessment is Issued in Accordance with Regulation (EU) No 305/2011, On the Basis Of:	EAD 330047-01-0602 – “Fastening Screws for Sandwich Panels”
This Version Replaces:	ETA 18/0942, Issued on 05/03/2020

Translations of this European Technical Assessment in other languages shall fully correspond to the original issued document and should be identified as such.

Communication of this European Technical Assessment, including transmission by electronic means, shall be in full (excepted the confidential Annex(es) referred to above). However, partial reproduction may be made, with the written consent of the issuing Technical Assessment Body. Any partial reproduction has to be identified as such.

1 Technical Description of the Product

The DrillFast and MatchFast HT fastening screws for sandwich panels are self-drilling screws manufactured of stainless steel and carbon steel and completed with aluminium or stainless-steel sealing washers. The carbon steel screws are coated by a multiple layer organic coating.

The material for the threaded part of the fastener can be identified from the head marking. The range of materials used for the fasteners is:

- A2/304 stainless steel, marked “A2” or “SS”
- A4/316 stainless steel, marked “A4”
- Hardened SAE 1022 carbon steel, no material mark.

The DrillFast (DF) fastener types have either a flanged 5/16” (~8 mm) AF Hex head or a pan head for a Torx drive.

MatchFast (MF) fastener types have a head with a coloured cap of exterior grade glass-filled nylon for an 11 mm bi/hex drive. The carbon steel MF fasteners have a four-pronged split head to which the cap is fitted. The stainless steel MF fasteners have the cap fitted to the same 8 mm AF Hex head as the equivalent DF fasteners.

Washers are used to seal under the flange for exterior applications. They are conical washers of aluminium or A4/316 stainless steel with an EPDM (ethylene propylene diene monomer) seal bonded to the inner face. The screws are to be tightened so that the EPDM seal is slightly compressed.

The fasteners are characterised by a length of smooth shank and an additional thread directly below the head, hence the “HT” code for High Thread

Various coloured finishing options are available for fastener heads to match their appearance to the sheeting. An “(L)” in the drawing indicates that the DrillFast fastener is available with a coloured lacquer finish. The nylon cap of a MatchFast fastener is available in a wide range of colours.

The range of fastening screws covered in this assessment is listed below:

Table 1 DF3 / MF3: DrillFast and MatchFast HT for point-side steel 1.2 to 3 mm thick

FixFast Code	Fastener Material	Head type	Nominal diameter mm	Available lengths mm
DF3-HT-5.5	Carbon steel	8 mm AF Hex head	5.5	65 85 105 130 150 180 200 250
MF3-HT-5.5	Carbon steel	11 mm bi/hex nylon cap	5.5	65 85 105 130 150 180 200 250

FixFast Code	Fastener Material	Head type	Nominal diameter mm	Available lengths mm
DF3-SS-HT-5.5	A2/304 stainless steel	8 mm AF Hex head	5.5	85 110 130 150 180 225 275
MF3-SS-HT-5.5	A2/304 stainless steel	11 mm bi/hex nylon cap	5.5	85 110 130 150 180 225 275
DF3-SSA4-P-HT-5.5	A4/316 stainless steel	Torx #25 pan head	5.5	115 155 240

Table 2 DF12 / MF12: DrillFast and MatchFast HT for point-side steel 4.0 to 12 mm thick

FixFast Code	Fastener Material	Head type	Nominal diameter mm	Available lengths mm
DF12-HT-5.5	Carbon steel	8 mm AF Hex head	5.5	85 105 125 145 165 185 205 255 305
MF12-HT-5.5	Carbon steel	11 mm bi/hex nylon cap	5.5	85 105 125 145 165 185 205 255
DF12-SS-HT-5.5	A2/304 stainless steel	8 mm AF Hex head	5.5	95 115 150 200 250 300

FixFast Code	Fastener Material	Head type	Nominal diameter mm	Available lengths mm
MF12-SS-HT-5.5	A2/304 stainless steel	11 mm bi/hex nylon cap	5.5	95 115 150 200 250
DF12-SSA4-P-HT-5.5	A4/316 stainless steel	Torx #25 pan head	5.5	165 230

Table 3 DF25: DrillFast HT for point-side steel 8.0 to 25 mm thick

FixFast Code	Fastener Material	Head type	Nominal diameter mm	Available lengths mm
DF25-SSA4-HT-6.3	A4/316 stainless steel	8 mm AF Hex head	6.3	225 275 325

Table 4 DFT / MFT: DrillFast and MatchFast HT for point-side timber

FixFast Code	Fastener Material	Head type	Nominal diameter mm	Available lengths mm
DFT-HT-5.5	Carbon steel	8 mm AF Hex head	5.5	80 100 130 180
MFT-HT-5.5	Carbon steel	11 mm bi/hex nylon cap	5.5	80 100 130 180

The number following “DF” or “MF” in the FixFast code is generally the point-side capacity of the fastener in steel. Fasteners of the same diameter and material will have the same thread and tip for a given drilling capacity.

Sealing washers are supplied in the following diameters:

- Aluminium washers: 10 mm, 15 mm, 19 mm and 29 mm; coded A10, A15, A19 and A29 respectively.
- Aluminium washers with a coloured lacquer finish: 29 mm only, coded L29.
- A4/316 stainless steel washers: 10 mm, 15 mm and 19 mm; coded S10, S15 and S19 respectively

2 Specification of the Intended Use(s) in Accordance with the Applicable European Assessment Document (hereinafter EAD)

The screws in this assessment are intended to be used for connecting composite insulated panels with steel facings to steel or timber framing members.

The component to be fastened (head-side) is referred to as substrate I, while the framing member or steel sheet (point-side) is referred to as substrate II.

The carbon steel screws may be used for indoor and outdoor applications with a corrosion category class C1 in accordance with Table B1 and Table B2 in EN 1993-1-3 and EN ISO 12944 2.

The A2/304 and A4/316 stainless steel screws may be used for indoor and outdoor applications with a corrosion category class of C1, C2 or C3. The A4/316 screws may also be used for applications with a corrosion category of C4.

The fastening screws are intended to be used with connections under predominantly static loads, such as wind and dead loads. The screws and their corresponding connections are subject to tension and shear forces as well as thermal expansion.

The fastening screws are intended for use with washers to spread axial loads and to provide a weatherproof seal. They should not be installed without a washer unless the panel is designed with an alternative means of spreading the load.

Under the provisions of this ETA and the assessment methods included in this evaluation report, the fastening screws may have an assumed intended working life of 25 years when installed in accordance with the manufacturer's instructions.

The indications given in this document cannot be interpreted as a guarantee given by the manufacturer but are regarded as means for choosing the appropriate products in relation to the expected economically reasonable working life of the works.

3 Performance of the Product and References to the Methods used for its Assessment

BWR	Characteristic	Assessment of Characteristic
1	Mechanical Resistance and Stability	See ETA Section 3.1.1
2	Safety in Case of Fire	See ETA Section 3.1.2
	Reaction to Fire	See ETA Section 3.1.2.1
	Resistance to Fire	See ETA Section 3.1.2.2
3	Other Aspects	
	Durability	See ETA Section 3.1.3.1

3.1 Methods of Verification

3.1.1 Mechanical Resistance and Stability

The mechanical resistance and stability has been determined as the characteristic shear and axial resistance of the fastening screws covered by this ETA. Values are given in Annex 1.

The axial resistance NR,k is taken as the minimum of the pull through and pull out resistances for the connection.

$$N_{R,k} = \min \begin{cases} N_{R,k,\text{Pull through}} \\ N_{R,k,\text{Pull out}} \end{cases}$$

Derivation of design resistance values to be used when designing in accordance with Eurocode 3 shall be taken as described in 3.8.2.

3.1.2 Safety in Case of Fire

3.1.2.1 Reaction to Fire

The product is considered to satisfy the requirements of Class A1 with regards to classification for reaction to fire, in accordance with the provisions of the EC Decision 96/603/EC (as amended) without the need for further testing.

3.1.2.2 Resistance to Fire

The assessment of the fastening screws with regards to resistance to fire performance is relevant to the systems as assembled (as fastening screws, steel members and substructures) and not the screws alone. Therefore, there is no performance determined for this aspect.

3.1.3 Other Aspects

3.1.3.1 Durability

The carbon steel screws may be used for indoor and outdoor applications with a corrosion category class C1 in accordance with Table B1 and Table B2 in EN 1993-1-3 and EN ISO 12944 2.

The A2/304 stainless steel screws may be used for indoor and outdoor applications with a corrosion category class of C1, C2 or C3.

The A4/316 stainless steel screws may be used for indoor and outdoor applications with a corrosion category class of C1, C2, C3 or C4.

3.2 General Aspects Related to the Performance of the Product

3.2.1 Manufacturing

The Fixfast fastening screws are manufactured in accordance with the provisions of this European Technical Assessment using the manufacturing process assessed and detailed in the technical documentation.

The European Technical Assessment is issued for the products covered on the basis of agreed data/information that has been deposited with Element Materials Technology Rotterdam B.V. and which identifies the products that have been assessed and judged. Changes to the products or the manufacturing process, that may result in the information submitted and held on file being incorrect, should be confirmed with Element Materials Technology Rotterdam B.V. before any modifications are implemented.

Element Materials Technology Rotterdam B.V. will decide on that basis whether or not such changes may affect the performance characteristics detailed in the ETAs and consequently the validity of the CE-marking. In that case additional assessment or modifications to the ETA and the corresponding evaluation report may be necessary.

3.2.2 Design of Connections Using the Product

For connections made with steel members and as described in the Annex of this ETA it is not required to consider and evaluate the limitations of the connections with regards to temperature effects. For other types of connections, the effect of temperature shall be considered for design purposes if the effect on the connections is not significant. Other types of connections affected by temperature are not covered by this ETA.

The characteristic capacities declared in this ETA are based on the dimensions, material properties, minimum effective length (minimum embedded threaded length in timber substrates) and nominal substrates thicknesses provided by the manufacturer and as stated in the ETA and its corresponding Annex.

To verify the design of connections made with the fastening screws listed in this ETA, the method given in EN 1990 is used to derive the design capacities based on the characteristic performance capacities stated in the Annex of this document.

Therefore, the design capacities to be used when designing in accordance with EN 1993-1-3 shall be derived using the following formulas:

Design shear resistance:

$$V_{R,d} = \frac{V_{R,k}}{\gamma_M}$$

Design axial resistance:

$$N_{R,d} = \frac{N_{R,k}}{\gamma_M}$$

Where $\gamma_M = 1.33$ if no other values are given in national regulations.

Where combined tension and shear forces occur within the connection, the interaction equation of EN1993-1-3, section 8.3 (8) must be verified, as follows:

$$\frac{N_{S,d}}{N_{R,d}} + \frac{V_{S,d}}{V_{R,d}} \leq 1.0$$

where $N_{S,d}$ and $V_{S,d}$ are the engineering design values for normal and shear forces respectively and $N_{R,d}$ and $V_{R,d}$ are the design resistance values in the connections for normal and shear forces respectively.

3.2.3 Installation

The installation must be carried out in accordance with the manufacturer's instructions which shall be provided to the installer. If carried out in accordance with the details given, the execution of the works should not promote bimetallic corrosion between metallic parts.

When shear forces act on the connection, the two components of the connection-substrate I and substrate II are connected to each other so that the fastening screws cannot incur additional bending stresses.

The fastening screws shall be installed perpendicular to the surface of the components and ensure the correct bearing is provided by the provision of the required washer specification. The fastener should be tightened so that the EPDM seal is slightly compressed to ensure a weathertight installation.

The fastening screws shall be selected as per recommendations of the manufacturer for the application required.

The installer shall fix the fastening screws for sandwich panels in accordance with the provisions of this ETA.

3.2.3.1 Installation Instructions

It is the responsibility of the manufacturer to ensure that the information on the specific conditions particularly regarding the product and its mechanical performance characteristics described in this evaluation report is supplied to those who are concerned. This information may be provided by reproduction of the corresponding parts of the European Technical Assessment.

The installation information including any pre-drilling, torque moment and application limits shall be supplied either part of the packaging or on the enclosed technical data sheet.

3.2.4 Identification of the Product

The product shall be identified with the mark of the manufacturer and the CE marking information.

3.2.5 Packaging, Transport and Storage

The products should be packed in boxes bearing the manufacturer's name, product type, nominal size, quantity, date of manufacture and batch reference details.

3.2.6 Use, Maintenance and Repair

The assessment of fitness for use is based on the assumption that maintenance is not required during the assumed intended working life.

Should repair be necessary, this is normally achieved by replacement. An assessment must be made by a design professional in each case.

4 Assessment and Verification of Constancy of Performance (hereinafter AVCP) System Applied, with reference to its Legal Base

4.1 System of Assessment and Verification of Constancy of Performance

According to the Decision 98/2147/EC of the European Commission, as amended, the System(s) of Assessment and Verification of Constancy of Performance (see Annex V to Regulation (EU) No 305/2011) is 2+.

5 Technical Details Necessary for the Implementation of the AVCP System, as foreseen in the applicable EAD

5.1 Tasks for the Manufacturer

5.1.1 Initial Type Testing of the Product

Initial Type Testing (ITT) and Assessment has been undertaken under the responsibility of the manufacturer to verify that the production line in question is able to manufacture products in conformity with this ETA.

Any changes in materials or the production process which would result in a change in the product characteristics, the tests and/or assessments shall be repeated for the appropriate characteristics. In such cases the necessary type testing has to be agreed between Element Materials Technology Rotterdam B.V. and the Notified Body.

5.1.2 Factory Production Control (FPC)

The manufacturer has a Factory Production Control System (FPC) and exercises permanent internal control of production. All the elements, requirements and provisions adopted by the manufacturer are documented in a systematic manner in the form of policies, procedures and work instructions. This FPC system ensures that the product is in conformity with this European Technical Assessment.

The manufacturer shall only use raw materials or components that are supplied with the relevant inspection documents. All incoming raw materials shall be subject to inspection, verification, controls and tests (as applicable) by the manufacturer.

The results of FPC are recorded and evaluated. These records include but are not limited to:

- Product specification and designation, basic materials and components
- Type(s) of Control testing
- Date of manufacture of the product and date of testing of the product or basic material and components
- Result of control and testing and, if appropriate, comparison with requirements
- Signature of the person responsible for FPC
- These records shall be presented to the Notified Body upon request.

5.1.3 Factory Testing / Assessment

In this context, testing is taken to mean physical testing and/or visual examination of the product/process.

The final products are checked visually and for dimensions as detailed in a prescribed test plan, which is part of the factory production control.

The manufacturer may only use the raw materials listed in the technical documentation of this ETA. The raw materials shall be subject to controls by the manufacturer.

The control shall include the test certificates presented by suppliers (comparison with nominal values), including verification of dimensions and determination of material properties, e.g. chemical composition, mechanical properties and thickness of the protective coating.

Details of the factory production control such as frequency, test methods, specificities, etc. are laid down in the prescribed Control Plan which has been deposited with Element Materials Technology Rotterdam B.V. and is made available to the Notified Body.

All measuring and testing equipment shall be regularly calibrated and inspected according to the documented FPC system. Production records shall be kept for each batch of fasteners for at least 10 years.

5.2 Tasks for the Notified Body

5.2.1 Initial Inspection of Factory and of Factory Production Control

An assessment of each production unit shall be carried out by the Notified Body to demonstrate that the factory production control is in conformity with the ETA and any subsidiary information. This assessment shall be based on an initial inspection of the factory. Subsequently continuing surveillance of factory production control, including verification that tests are being carried out to the prescribed test plan, is necessary to ensure continuing conformity with the ETA.

5.2.2 Continuing Surveillance

The Notified Body shall visit the factory twice a year for regular inspection. It shall be verified that the system of factory production control and the specified manufacturing process is maintained in accordance with this European Technical Assessment.

In cases where the provisions of this European Technical Assessment are no longer fulfilled, the conformity certificate shall be withdrawn.

Issued in Amsterdam, Netherlands on 15/12/2020

By

A handwritten signature in black ink, appearing to read 'Niresh D Somlie', with a horizontal line underneath.

Niresh D Somlie

Technical Assessment Body Manager

Annex 1: Product Description and Application

In this Annex, fasteners are sorted as follows

- 1 – by Thread Type: DF3, DF12, DF25, DFT
- 2 – by Thread Material: Carbon Steel, Stainless Steel
- 3 – by Manufacturer Code

DF3-HT-5.5

NTROLL

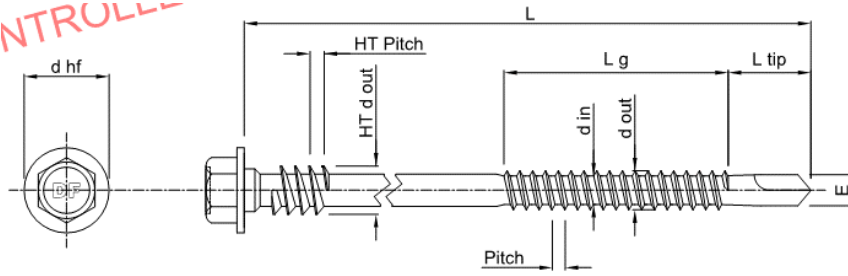

Product code DF3-HT-5.5 * 140

Applicable washer variants for product

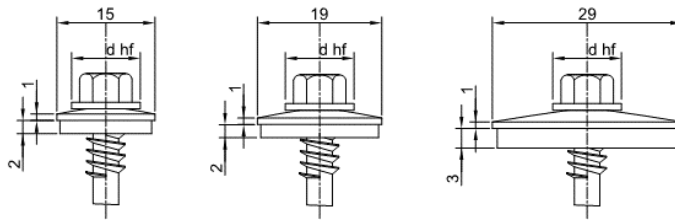

L	140 mm
d out	5.38 mm
d in	4.08 mm
L tip	15 mm max
L g	60 mm min
d tip	4.20 mm
d hf	11.8 mm
Pitch	1.81 mm
HT d out	6.80 mm
HT Pitch	2.00 mm

Length range

L (mm)	65	85	105	130	150	180	200	250
L _g (mm)	32	42	42	60	70	70	70	70

- Material: SAE1022 carbon steel thread
 Drill Capacity: For min 1.2 up to 3.0 mm thick steel sheet
 Also used with a timber substrate
 Head Type: 8 mm AF Hex head
 Washer: A15, A19, A29

In Steel

Substrate I t_i (mm)	Substrate II t_{ii} (mm)	$N_{R,k}$ (kN)	$N_{R,d}$ (kN)	$V_{R,k}$ (kN)	$V_{R,d}$ (kN)
≥0.5	≥1.2	1.43	1.08	0.98	0.74
≥0.5	≥2.0	2.75	2.07	0.98	0.74
≥0.5	3.0	3.28	2.47	0.98	0.74
≥0.7	3.0	4.90	3.68	0.98	0.74

- Substrate I is the thickness of the outer face of the sandwich (CIP) panel.
- Substrate II is the thickness of the supporting steel construction.
- Shear values are for a sandwich (CIP) panel with a 0.5 mm thick inner face.

In Timber

Substrate I t_i (mm)	Substrate II l_e (mm)	$N_{R,k}$ (kN)	$N_{R,d}$ (kN)	$V_{R,k}$ (kN)	$V_{R,d}$ (kN)
≥ 0.5	32	2.05	1.54	0.98	0.74
≥ 0.5	42	2.68	2.02	0.98	0.74
≥ 0.5	60	<u>3.28</u>	<u>2.47</u>	0.98	0.74
≥ 0.7	60	3.83	2.88	0.98	0.74
≥ 0.5	70	<u>3.28</u>	<u>2.47</u>	0.98	0.74
≥ 0.7	70	4.47	3.36	0.98	0.74

- Substrate I is the thickness of the outer face of the sandwich (CIP) panel.
- Substrate II is the length of fastener thread assumed to be embedded in the timber substrate
- Shear values are for a sandwich (CIP) panel with a 0.5 mm thick inner face.
- Resistance values are for C16 or better

 $N_{R,k} = 4.47$ (kN) and $N_{R,d} = 3.36$ (kN) for the longest embedded length in C16 timber or better and should be reduced proportionally for shorter embedded lengths unless the head side value is critical (underlined).
 The embedded length should not be less than 6 times the outer thread diameter to comply with Eurocode 5.

DF3-SS-HT-5.5

TRULL

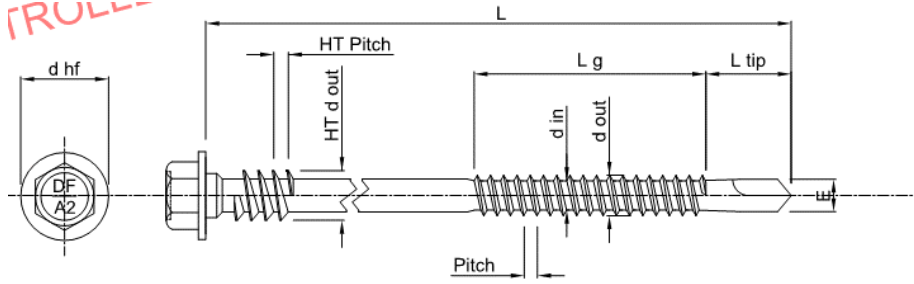

L	130 mm
d out	5.38 mm
d in	4.08 mm
L tip	10 mm max
L g	61 mm max
d tip	4.40 mm
d hf	12.0 mm
Pitch	1.81 mm
HT d out	6.80 mm
HT Pitch	2.00 mm

Product code DF3-SS-HT-5.5 * 130

Applicable washer variants for product

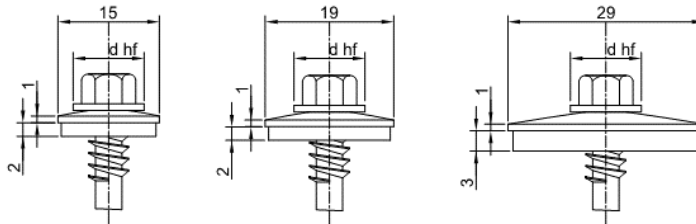

Length range

L (mm)	85	110	130	150	180	225	275
L _g (mm)	41	51	61	61	76	86	86

Material: A2/304 stainless steel thread
 Drill Capacity: For min 1.2 up to 3.0 mm thick steel sheet
 Head Type: 8 mm AF Hex head
 Washer: A15, A19, A29

Substrate I t_i (mm)	Substrate II t_{ii} (mm)	$N_{R,k}$ (kN)	$N_{R,d}$ (kN)	$V_{R,k}$ (kN)	$V_{R,d}$ (kN)
≥0.5	≥1.2	1.43	1.08	0.98	0.74
≥0.5	≥2.0	2.75	2.07	0.98	0.74
≥0.5	≥3.0	3.28	2.47	0.98	0.74
≥0.7	≥3.0	4.90	3.68	0.98	0.74

- Substrate I is the thickness of the outer face of the sandwich (CIP) panel.
- Substrate II is the thickness of the supporting steel construction.
- Shear values are for a sandwich (CIP) panel with a 0.5 mm thick inner face.

DF3-SSA4-P-HT-5.5

INTRUOL

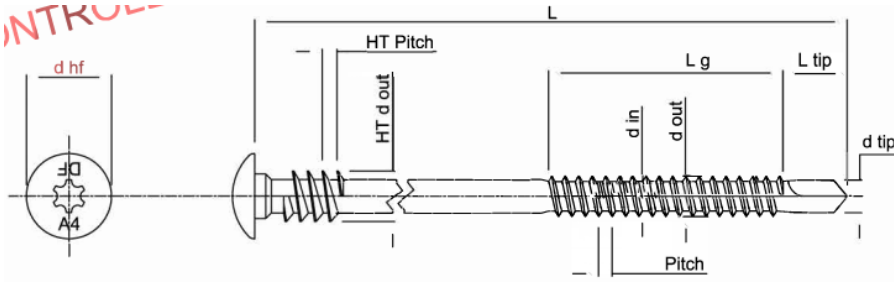

Product code DF3-SSA4-P-HT-5.5 * 115-240

L	115/155/240mm
d out	5.38 mm
d in	4.08 mm
L tip	12 mm max
L g	55 mm min
d tip	4.20 mm
d hf	11.8 mm
Pitch	1.81 mm
HT d out	6.80 mm
HT Pitch	2.00 mm

Applicable washer variants for product

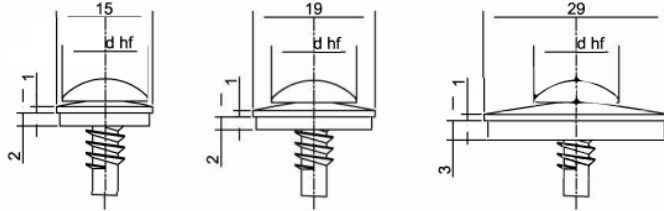

Length range

L (mm)	115	155	240
L _g (mm)	60	60	100

Material: A4/316 stainless steel thread
 Drill Capacity: For min 1.2 up to 3.0 mm thick steel sheet
 Head Type: Torx #25 pan head
 Washer: S15, S19, A29

Substrate I t_i (mm)	Substrate II t_{II} (mm)	$N_{R,k}$ (kN)	$N_{R,d}$ (kN)	$V_{R,k}$ (kN)	$V_{R,d}$ (kN)
≥ 0.5	≥ 1.2	1.43	1.08	0.98	0.74
≥ 0.5	≥ 2.0	2.75	2.07	0.98	0.74
≥ 0.5	≥ 3.0	3.28	2.47	0.98	0.74
≥ 0.7	≥ 3.0	4.90	3.68	0.98	0.74

- Substrate I is the thickness of the outer face of the sandwich (CIP) panel.
- Substrate II is the thickness of the supporting steel construction.
- Shear values are for a sandwich (CIP) panel with a 0.5 mm thick inner face.

DF12-HT-5.5

CONTROLLED

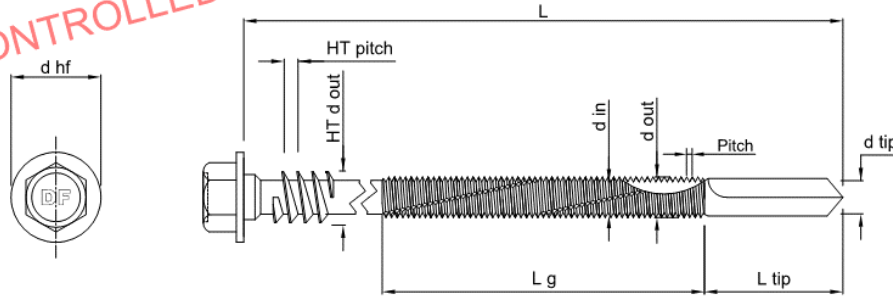

L	145 mm
d out	5.40 mm
d in	4.15 mm
L tip	22 mm max
L g	72 mm max
d tip	4.87 mm
d hf	11.7 mm
Pitch	1.06 mm
HT d out	6.80 mm
HT Pitch	2.00 mm

Product code DF12-HT-5.5 *145

Applicable washer variants for product

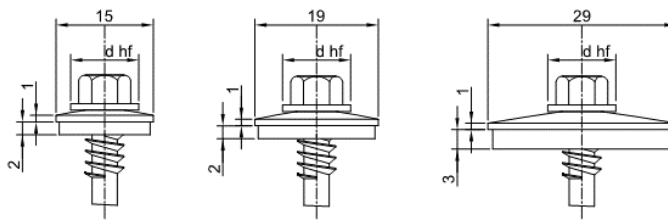

Length range

L (mm)	85	105	125	145	165	185	205	255	305
L _g (mm)	45	65	65	72	83	83	83	103	103

Material: SAE1022 carbon steel thread
 Drill Capacity: For min 4.0 up to 12.0 mm thick steel
 Head Type: 8 mm AF Hex head
 Washer: A15, A19, A29

Substrate I t _i (mm)	Substrate II t _{ii} (mm)	N _{R,k} (kN)	N _{R,d} (kN)	V _{R,k} (kN)	V _{R,d} (kN)
≥0.5	≥4.0	3.28	2.47	0.98	0.74
≥0.7	≥4.0	5.10	3.84	0.98	0.74

- Substrate I is the thickness of the outer face of the sandwich (CIP) panel.
- Substrate II is the thickness of the supporting steel construction.
- Shear values are for a sandwich (CIP) panel with a 0.5 mm thick inner face.

DF12-SS-HT-5.5

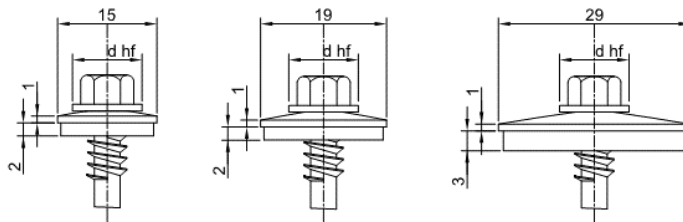
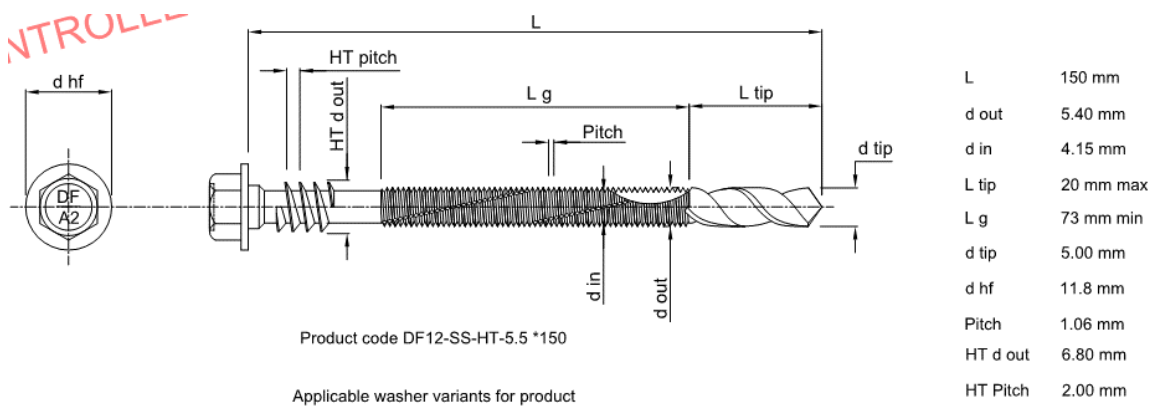

Length range

L (mm)	95	115	150	200	250	300
L _g (mm)	48	73	73	88	88	88

Material: A2/304 stainless steel thread
 Drill Capacity: For min 4.0 up to 12.0 mm thick steel
 Head Type: 8 mm AF Hex head
 Washer: A15, A19, A29

Substrate I t _i (mm)	Substrate II t _{ii} (mm)	N _{R,k} (kN)	N _{R,d} (kN)	V _{R,k} (kN)	V _{R,d} (kN)
≥0.5	≥4.0	3.28	2.47	0.98	0.74
≥0.7	≥4.0	4.02	3.02	0.98	0.74
≥0.7	≥6.0	5.10	3.84	0.98	0.74

- Substrate I is the thickness of the outer face of the sandwich (CIP) panel.
- Substrate II is the thickness of the supporting steel construction.
- Shear values are for a sandwich (CIP) panel with a 0.5 mm thick inner face.

DF12-SSA4-P-HT-5.5

L	d out	d in	L tip	L g	d tip	d hf	Pitch	HT d out	HT Pitch
165 mm	5.40 mm	4.15 mm	20 mm Max	90 mm	5.00 mm	11.8 mm	1.06 mm	6.80 mm	2.00 mm

Length Range

L (mm)	165	230
L _g (mm)	90	90

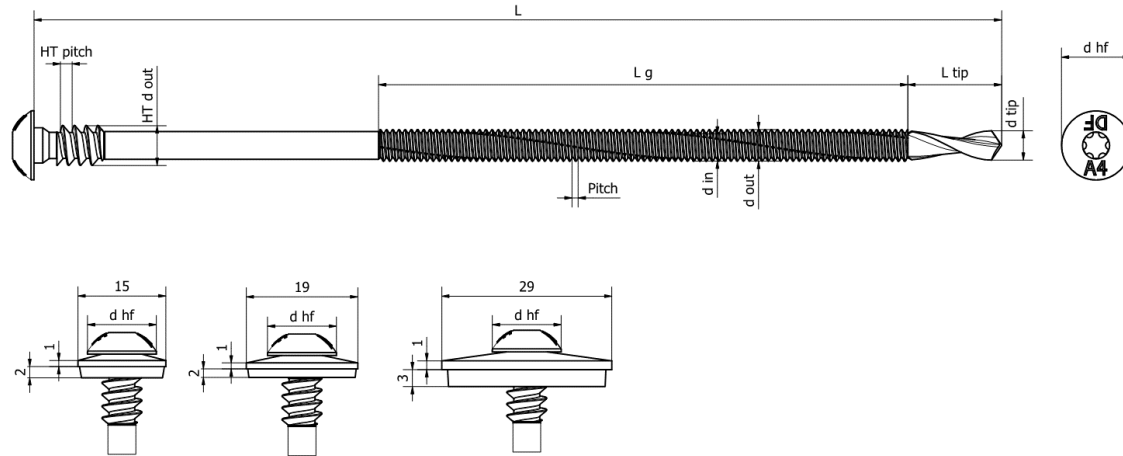

Length range

L (mm)	165	230
L _g (mm)	90	90

Material: A4/316 stainless steel thread
 Drill Capacity: For min 4.0 up to 12.0 mm thick steel
 Head Type: Torx #25 pan head
 Washer: S15, S19, A29, Superflat

Substrate I t_i (mm)	Substrate II t_{II} (mm)	$N_{R,k}$ (kN)	$N_{R,d}$ (kN)	$V_{R,k}$ (kN)	$V_{R,d}$ (kN)
≥0.5	≥4.0	3.28	2.47	0.98	0.74
≥0.7	≥4.0	4.02	3.02	0.98	0.74
≥0.7	≥6.0	5.10	3.84	0.98	0.74

- Substrate I is the thickness of the outer face of the sandwich (CIP) panel.
- Substrate II is the thickness of the supporting steel construction.
- Shear values are for a sandwich (CIP) panel with a 0.5 mm thick inner face.

DF25-SSA4-HT-6.3

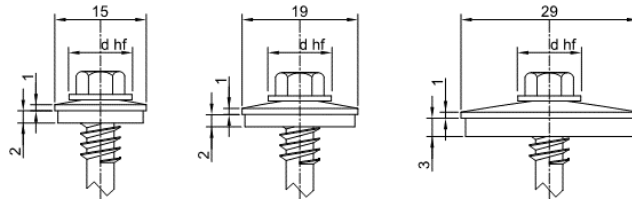
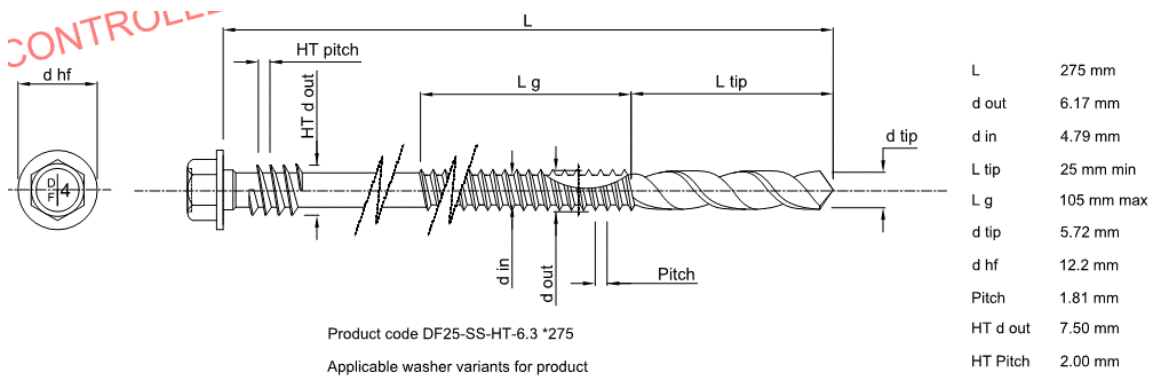

Length range

L (mm)	225	275	325
L _g (mm)	105	105	105

Material: A4/316 stainless steel thread
 Drill Capacity: For min 8.0 up to 25.0 mm thick steel
 Head Type: 8 mm AF Hex head
 Washer: S15, S19, A29

Substrate I t _i (mm)	Substrate II t _{ii} (mm)	N _{R,k} (kN)	N _{R,d} (kN)	V _{R,k} (kN)	V _{R,d} (kN)
≥0.5	≥8.0	3.28	2.47	0.93	0.70
≥0.7	≥8.0	5.10	3.84	0.93	0.70

- Substrate I is the thickness of the outer face of the sandwich (CIP) panel.
- Substrate II is the thickness of the supporting steel construction.
- Shear values are for a sandwich (CIP) panel with a 0.5 mm thick inner face.

DFT-HT-5.5

NIR

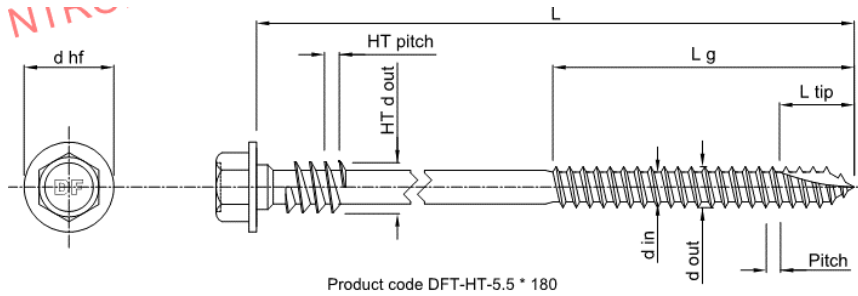

Product code DFT-HT-5.5 * 180

L	180 mm
d out	5.53 mm
d in	4.02 mm
L tip	11 mm max
L g	62 mm max
d hf	11.8 mm
Pitch	2.30 mm
HT d out	6.80 mm
HT Pitch	2.00 mm

Applicable washer variants for product

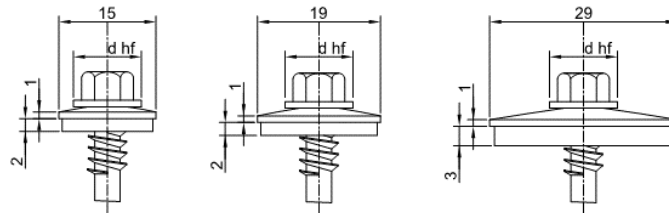

Length range

L (mm)	80	100	130	180
L _g (mm)	42	52	52	62

Material: SAE1022 carbon steel thread
 Drill Capacity: For a timber substrate
 Head Type: 8 mm AF Hex head
 Washer: A15, A19, A29

Substrate I t _i (mm)	Substrate II l _e (mm)	N _{R,k} (kN)	N _{R,d} (kN)	V _{R,k} (kN)	V _{R,d} (kN)
≥0.5	42	3.13	2.35	0.79	0.59
≥0.5	52	<u>3.28</u>	<u>2.47</u>	0.79	0.59
≥0.7	52	3.87	2.91	0.79	0.59
≥0.5	62	<u>3.28</u>	<u>2.47</u>	0.79	0.59
≥0.7	62	4.62	3.47	0.79	0.59

- Substrate I is the thickness of the outer face of the sandwich (CIP) panel.
 - Substrate II is the length of fastener thread assumed to be embedded in the timber substrate
 - Shear values are for a sandwich (CIP) panel with a 0.5 mm thick inner face.
 - Resistance values are for C16 or better
- N_{R,k} = 4.62 (kN) and N_{R,d} = 3.47 (kN) for the longest embedded length in C16 timber or better and should be reduced proportionally for shorter embedded lengths unless the head side value is critical (underlined).
 The embedded length should not be less than 6 times the outer thread diameter to comply with Eurocode 5.